

RECEPTACLE, PANEL MOUNTED

Part No.	ME 530R5W
Description:	30 Amp 3 Y 347/600Vac 4 Pole, 5 Wire Receptacle
Construction:	Watertight IEC IP 67
Approvals:	UL Listed Standards 1682; 1686 CSA Certification to Spec. C22.2 No. 182.1 IEC 60309-1; IEC 60309-2

IEC COLOR CODE: Black

GROUND SOCKET: 5 Hour Position Mates with Male in 7 Hour Position.

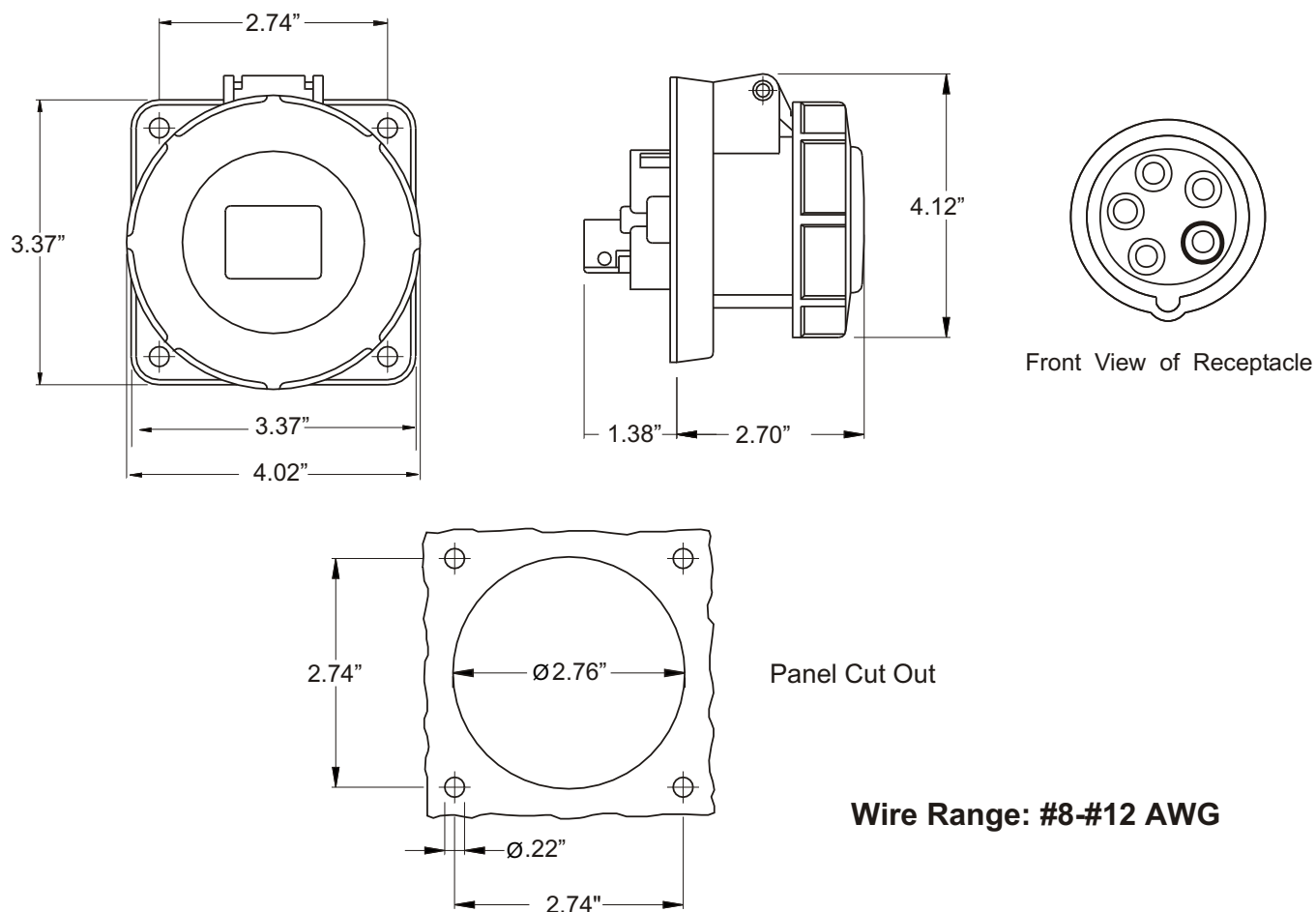

Wire Range: #8-#12 AWG

Drawing Not to Scale